

TO-92 Plastic-Encapsulate Transistors

FEATURES

- TRANSISTOR (NPN)
- Complementary to S9012
- Excellent hFE linearity

MECHANICAL DATA

- Case style: TO-92 molded plastic
- Mounting position: any

TO-92

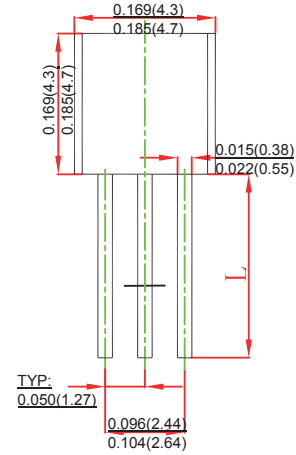

MAXIMUM RATINGS AND CHARACTERISTICS

@ 25°C Ambient Temperature (unless otherwise noted)

Symbol	Parameter	Value	Unit
V _{CBO}	Collector-Base Voltage	40	V
V _{CEO}	Collector-Emitter Voltage	25	V
V _{EBO}	Emitter-Base Voltage	5	V
I _C	Collector Current -Continuous	0.5	A
P _D	Collector Power Dissipation	625	mW
R _{θJA}	Thermal Resistance from Junction to Ambient	200	°C /W
T _j	Junction Temperature	150	°C
T _{stg}	Storage Temperature	-55~+150	°C

ELECTRICAL CHARACTERISTICS Ta =25°C unless otherwise specified

Parameter	Symbol	Test conditions	Min	Typ	Max	Unit
Collector-base breakdown voltage	V _{(BR)CBO}	I _C = 100μA , I _E =0	40			V
Collector-emitter breakdown voltage	V _{(BR)CEO}	I _C = 1mA , I _B =0	25			V
Emitter-base breakdown voltage	V _{(BR)EBO}	I _E = 100μA , I _C =0	5			V
Collector cut-off current	I _{CBO}	V _{CB} = 40V , I _E =0			0.1	μA
Collector cut-off current	I _{CEO}	V _{CE} =20V , I _E =0			0.1	μA
Emitter cut-off current	I _{EBO}	V _{EB} = 5V , I _C =0			0.1	μA
DC current gain	h _{FE(1)}	V _{CE} =1V, I _C =50mA	64		400	
	h _{FE(2)}	V _{CE} =1V, I _C = 500mA	40			
Collector-emitter saturation voltage	V _{CE(sat)}	I _C = 500mA, I _B = 50mA			0.6	V
Base-emitter voltage	V _{BE(sat)}	I _C = 500mA, I _B = 50mA			1.2	V
Transition frequency	f _T	V _{CE} =6V, I _C =20mA, f=30MHz	150			MHz

CLASSIFICATION OF h_{FE(1)}

Rank	D	E	F	G	H	I	J
Range	64-91	78-112	96-135	112-166	144-202	190-300	300-400

RATINGS AND CHARACTERISTIC CURVES

Typical Characteristics

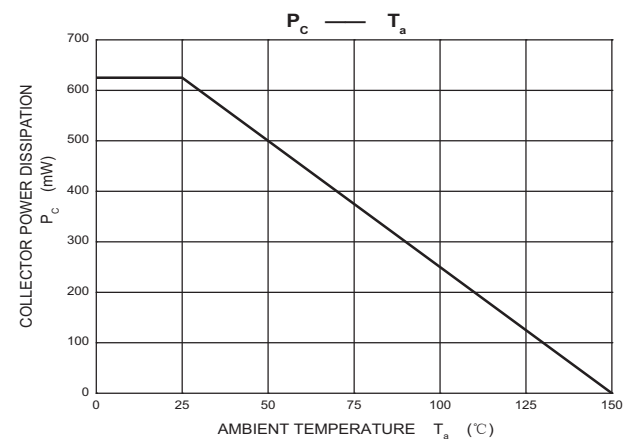
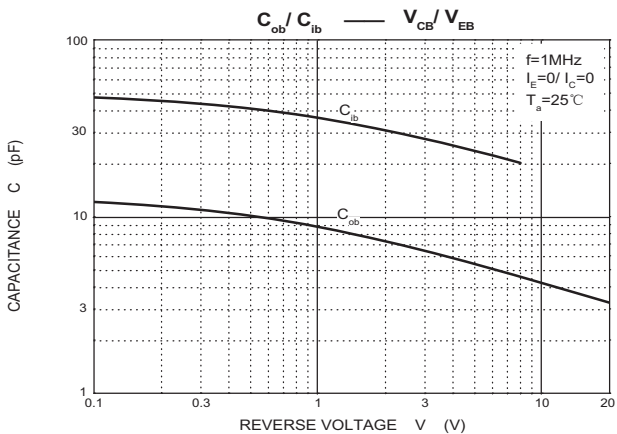
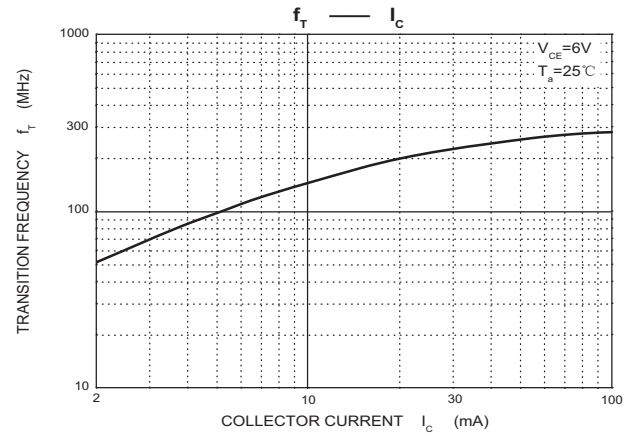
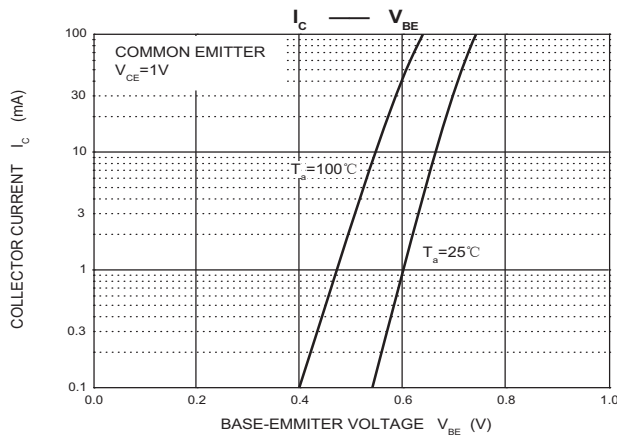
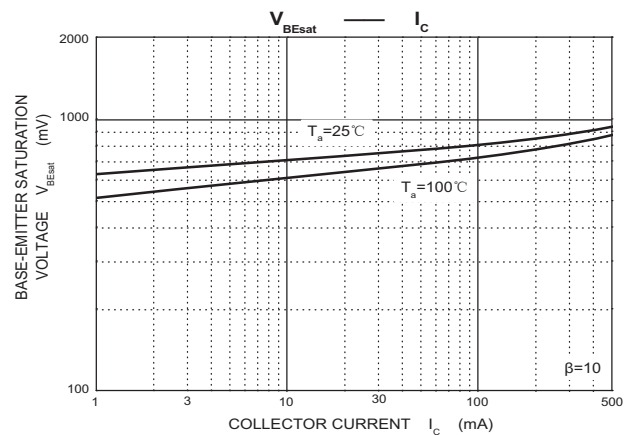
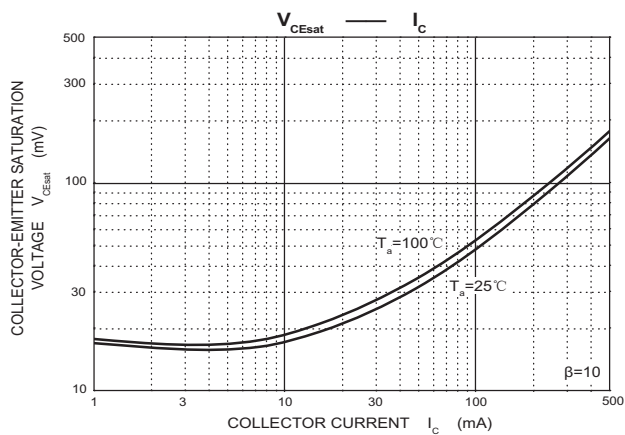
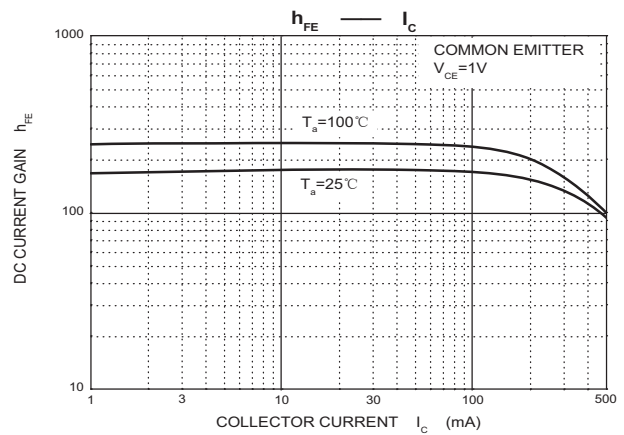
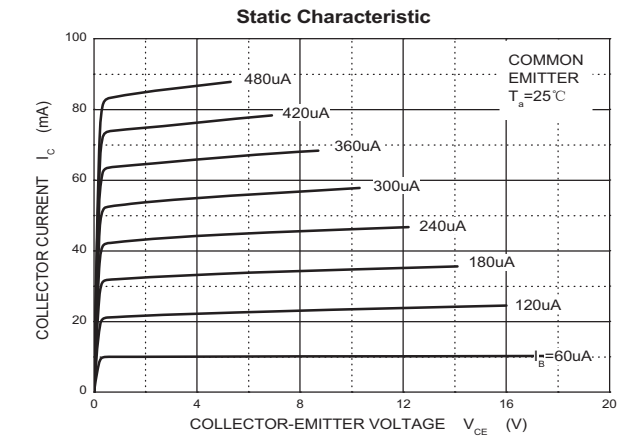

TO-92 Tape and Reel

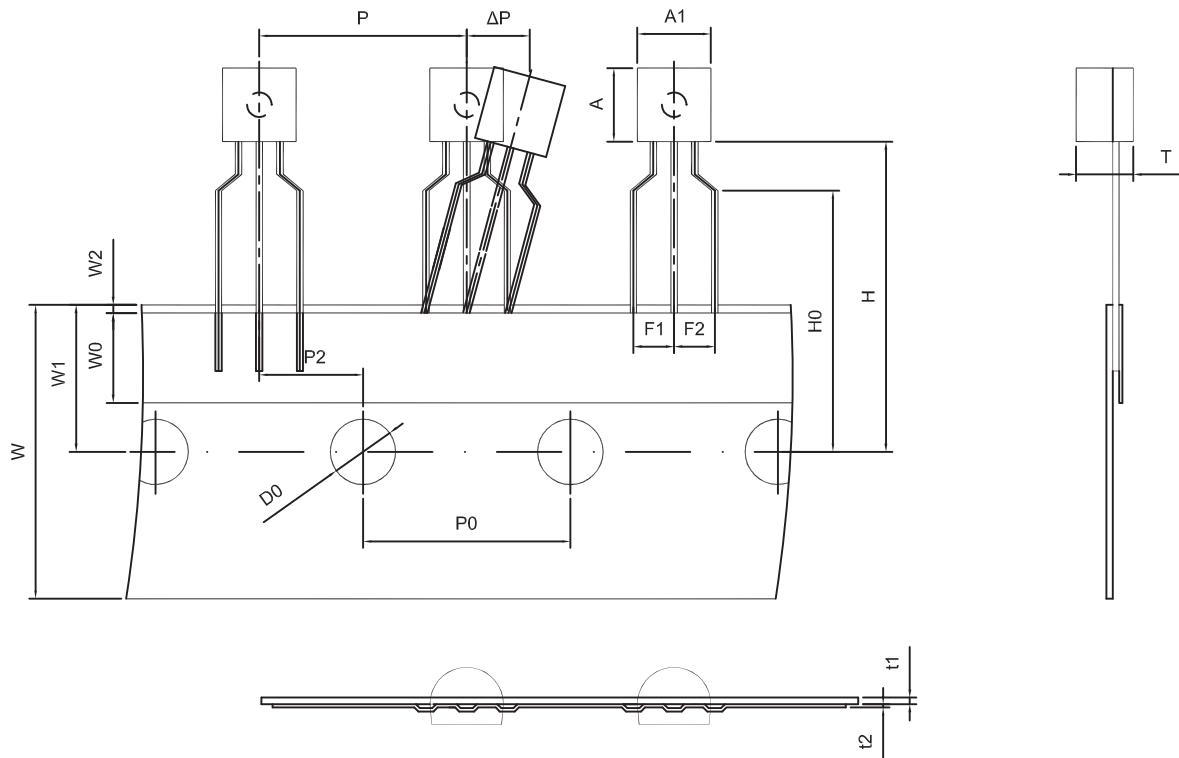

Dimensions are in millimeter

A1	A	T	P	P0	P2	F1	F2	W
4.5	4.5	3.5	12.7	12.7	6.35	2.5	2.5	18.0
W0	W1	W2	H	H0	D0	t1	t2	ΔP
6.0	9.0	1.0 MAX.	19.0	16.0	4.0	0.4	0.2	0

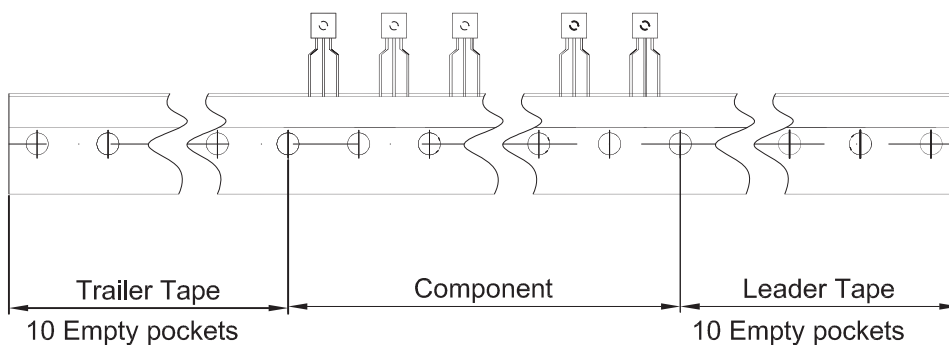

Package	Box	Box Size(mm)	Carton	Carton Size(mm)
TO-92	2000 pcs	333×162×43	20,000 pcs	350×340×250