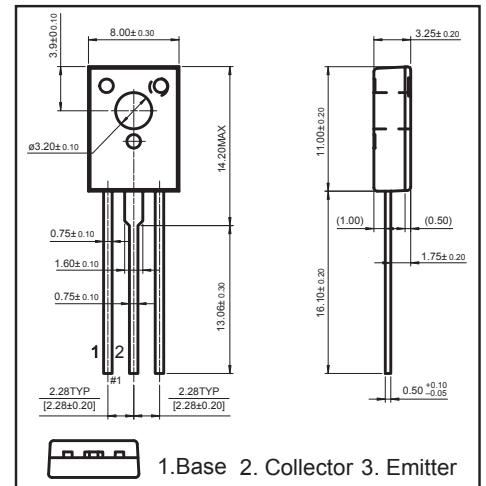

TO-126 Plastic-Encapsulate Transistors
FEATURES

- Low Frequency Power Amplifier
- High Current
- TRANSISTOR (NPN)

MECHANICAL DATA

- Case style: TO-126 molded plastic
- Mounting position: any

MAXIMUM RATINGS AND CHARACTERISTICS

@ 25°C Ambient Temperature (unless otherwise noted)

Parameter	Symbol	Value	Unit
Collector- Base Voltage	V_{CBO}	180	V
Collector-Emitter Voltage	V_{CEO}	160	V
Emitter-Base Voltage	V_{EBO}	5	V
Collector Current -Continuous	I_C	1.5	A
Collector Dissipation	P_C	1	W
Junction Temperature	T_J	150	°C
Storage Temperature	T_{stg}	-55 ~+150	°C

Parameter	Symbol	Test Conditions	Min	Typ	Max	Unit
Collector-base breakdown voltage	$V_{(BR)CBO}$	$I_C=1mA, I_E=0$	180			V
Collector-emitter breakdown voltage	$V_{(BR)CEO}$	$I_C=10mA, I_B=0$	160			V
Emitter-base breakdown voltage	$V_{(BR)EBO}$	$I_E=1mA, I_C=0$	5			V
Collector cut-off current	I_{CBO}	$V_{CB}=160V, I_E=0$			10	μA
Emitter cut-off current	I_{EBO}	$V_{EB}=4V, I_C=0$			10	μA
DC current gain	$h_{FE(1)}$	$V_{CE}=5V, I_C=150mA$	60		200	
	$h_{FE(2)}$	$V_{CE}=5V, I_C=500mA$	30			
Collector-emitter saturation voltage	$V_{CE(sat)}$	$I_C=500mA, I_B=50mA$			1	V
Base-emitter voltage	V_{BE}	$V_{CE}=5V, I_C=150mA$			1.5	V
Transition frequency	f_T	$V_{CE}=5V, I_C=500mA$		140		MHz
Collector output capacitance	C_{ob}	$V_{CB}=10V, I_E=0, f=1MHz$		14		pF

RATINGS AND CHARACTERISTIC CURVES

